

PORCINO

by Miniforms Lab

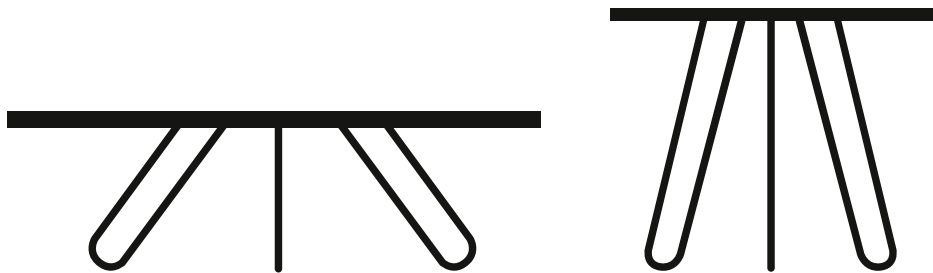

Ogni Porcino è unico; il piano è ottenuto con un tranciato tagliato trasversalmente che rende ogni pezzo irripetibile per dimensioni e venature. È un tavolino eclettico che affianca poltrone, divani e letti, evocando i sapori del bosco.

Every Porcino is unique; the top is made from a horizontal slice of wood, which makes every piece unrepeatable in terms of size and grain. This eclectic coffee table can be matched with armchairs, sofas and beds, evoking a forest-like atmosphere.

DIMENSIONI | DIMENSIONS



lunghezza | width: 80 cm
larghezza | depth: 80 cm
altezza | height: 37 cm

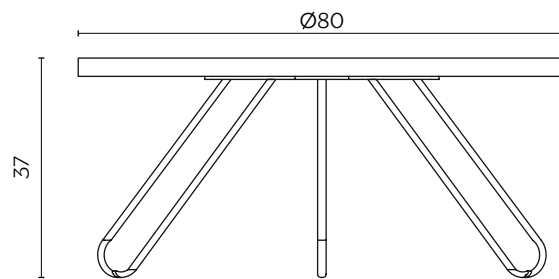

lunghezza | width: 60 cm
larghezza | depth: 60 cm
altezza | height: 56 cm

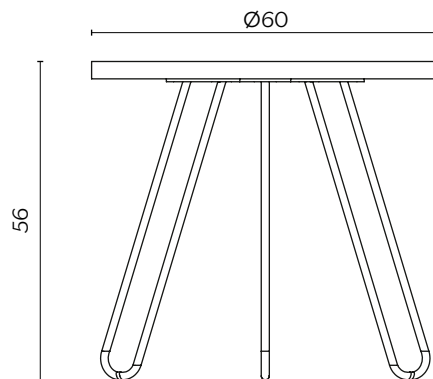

FINITURE PIANO | TOP FINISHES

LEGNO | WOOD



Corteccia di rovere
Oak bark

FINITURE GAMBE | LEGS FINISHES

LACCATO | LACQUER

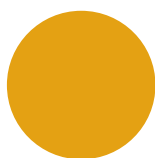

Zucca
NCS S2070-Y10R

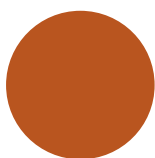

Mattone
NCS S3060-Y60R

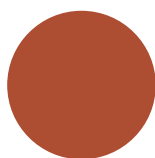

Pompei
NCS 4550-Y70R

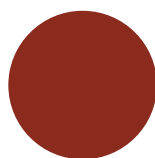

Bloody Mary
NCS 4550-Y80R

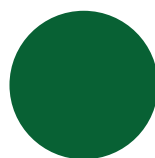

Pino
NCS S5040-G10Y

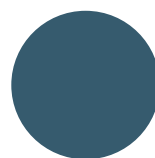

Bisanzio
NCS 6030-B

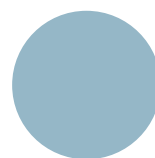

Nuvola
NCS S2020-B



Bianco
NCS S0502-Y



Burro
NCS S0510-G80Y



Creta
NCS S2005-Y10R



Grigio Seta
NCS S2502-Y

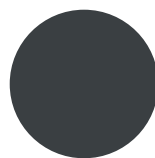

Antracite
NCS S7005-B20G

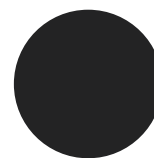

Nero
NCS S9000-N